

# Cox Digital Cable™

## User's Guide

Everything you need to know about  
your new Cox Digital Cable service



# Contents

Cox Digital Cable Converters.....	4
Explorer 2000.....	4
Explorer 2100.....	4
Standard Connection.....	5
Cox Digital Cable Remote Controls .....	6
Scientific Atlanta Remote .....	6
CheakMate™ Remote.....	7
Programming and Operating Instructions .....	9
TV Set Up Codes.....	14
VCR Set Up Codes.....	15
Receiver/Amplifier Codes.....	16
Programming and Operating Instructions ( <i>continued</i> ).....	17
Interactive program Guide (IPG).....	23
Browse by Time.....	23
Browse by Theme/Title/Date.....	23
Browse by Title.....	24
Cox iN DEMAND Pay-Per-View.....	25
What is Cox iN DEMAND Pay-Per-View?.....	25
How to Order Cox iN DEMAND Pay-Per-View.....	25
How to Change Your Cox iN DEMAND Pay-Per-View PIN .....	25
How to See What You Have Ordered.....	26
How to Cancel a Cox iN DEMAND Order .....	27
Parental Control.....	28
What is Parental Control?.....	28
How to Change Your Parental Blocking PIN.....	28
How to Block Channels .....	29
How to Watch a Blocked Program .....	29
How to Turn Parental Control Off.....	30
Using the VCR Commander .....	31
What is the VCR Commander .....	31
Installing the VCR Commander.....	31
How to Record Current Programming .....	33
How to Record Future Programming .....	33

# Cox Digital Cable Converters

## Explorer 2000 Converter

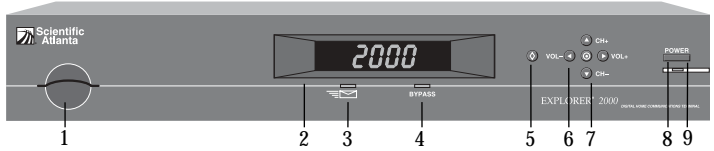

**Note:** Throughout this Guide, the terms Digital Converter and Explorer 2000 are used interchangeably.

1. Allows smart card access
2. Displays the channel number and time of day
3. Indicates a message is waiting when blinking or lit
4. Indicates optional bypass feature is on when lit (not used at this time)
5. Technical personnel use only
6. Increase or decrease volume
7. Scrolls up or down through the channels
8. Illuminates when power is on
9. Power on/off

## Explorer 2100 Converter

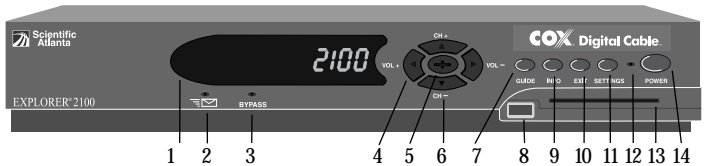

**Note:** Throughout this Guide, the terms Digital Converter and Explorer 2100 are used interchangeably.

1. Displays the channel number and time of day
2. Indicates a message is waiting when blinking or lit
3. Indicates optional bypass feature is on when lit (not used at this time)
4. Increase or decrease volume
5. Confirms or accesses on-screen options
6. Scrolls up or down through the channels
7. Accesses on-screen, Interactive Program Guide (IPG)
8. Connects to external equipment (not used at this time)
9. Accesses program information
10. Exits menus, guide, or program information
11. Accesses Settings menu
12. Illuminates when power is on
13. Allows smart card access (not currently active)
14. Power on/off

# Cox Digital Cable Converters, *cont.*

## Standard Connection

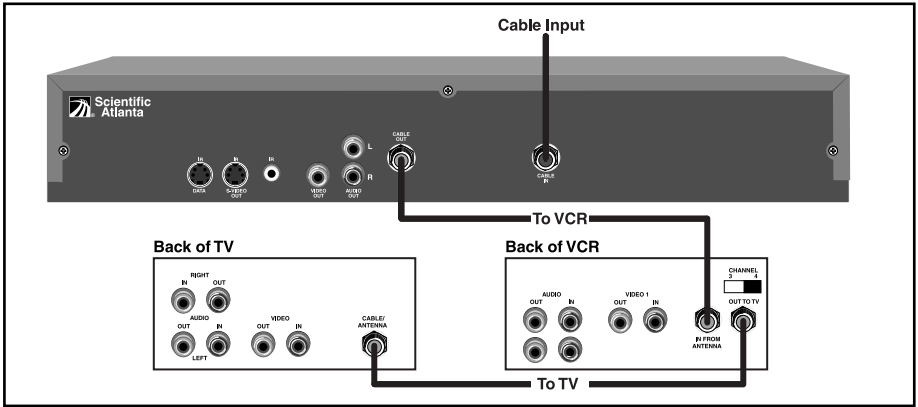

### ***WARNING!***

To prevent electric shock, match wide blade of power plug to wide slot, and fully insert.



### ***Caution:***

Before you turn on the power to the digital converter, install the AC power plug into the EXPLORER converter *first*, then plug it into an electrical outlet.

Be sure the cable connection to the television and digital converter are “finger tight” only. Never use a wrench to tighten these connections.

# Cox Digital Cable Remote Controls

## Scientific Atlanta Remote

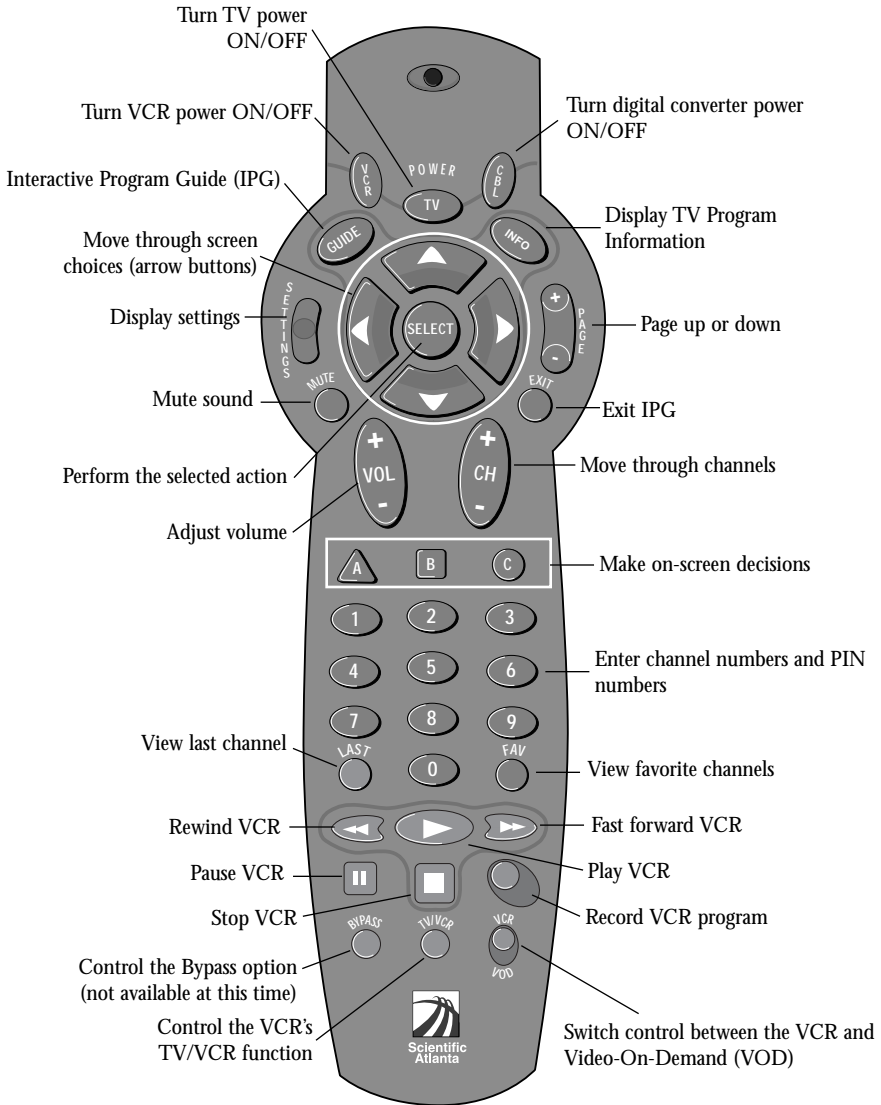

# Cox Digital Cable Remote Controls, *cont.*

## CheckMate III™ Remote

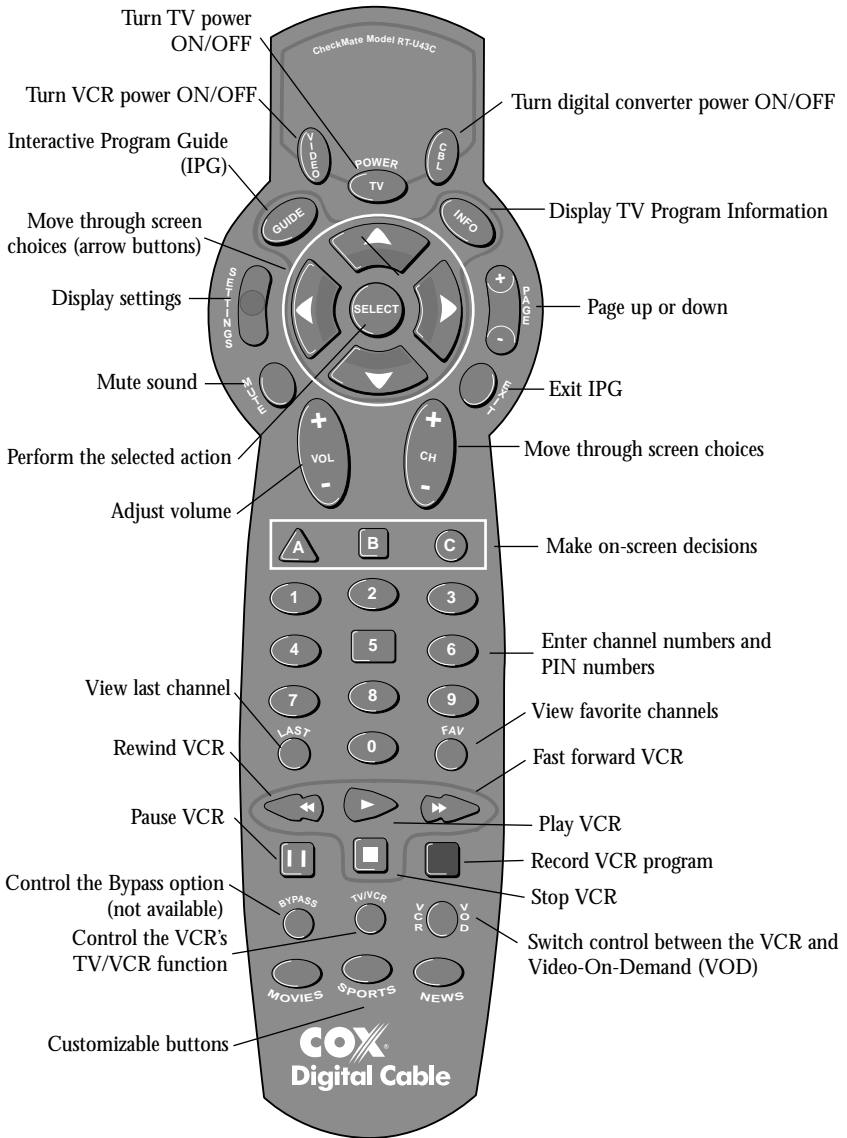

# Cox Digital Cable Remote Controls, *cont.*

## CheckMate IV™ Remote

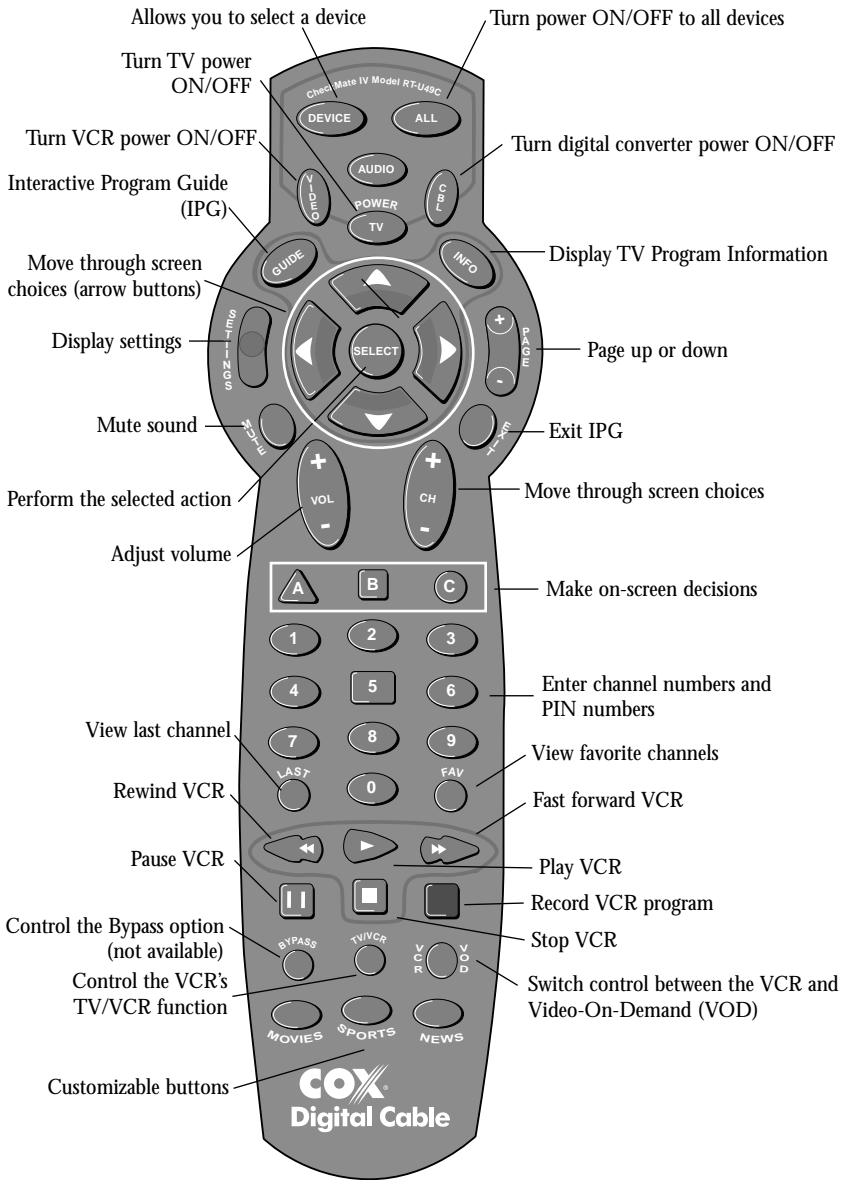

## Programming And Operating Instructions

To have a clearer idea of the features and capabilities of your remote control, take a moment to read these instructions. Save for future reference.

### Introduction

Your Scientific Atlanta/CheckMate universal remote controls are simple to program, easy to use, and can operate up to four (4) devices, which include:

**Cable** Cable television converters

**TV** Televisions

**Video** VCR, DVD

**Audio** Cassette deck, CD, receivers, amplifiers, 2nd TV, 2nd VCR.

Before you can use your remote control, it must be programmed (set-up) to operate the above devices.

### Special features

Some of the special features and buttons on your remote control are as follows:

#### **Point and Press Programming**

Lets you program your TV, VCR, Audio, other devices without codes

**[ALL]** (CheckMate IV remote only)

Turns all of your devices on/off with one button press. [All] can even be programmed to automatically tune your TV to its correct output channel.

**[Movies], [Sports], [News]** (CheckMate remote only)

Program your favorite channels on the "Movies", "Sports" and "News" buttons.

#### **[VCR/VOD] Toggle/button**

"Toggles" the VCR buttons between cable VOD (video-on-demand) and VCR/DVD functions.

**[Device]** (CheckMate IV remote only)

Tells which device you are currently operating by illuminating the device's power button. While the current device is illuminated, press a non-illuminated power button to operate a different device.

#### **Memory Guard™**

Eliminates reprogramming after battery changes.

#### **Time Out**

Shuts remote off if any button is pressed and held for 45 seconds. This extends battery life in the event the remote becomes lodged under or between heavy objects.

#### **Total Reset**

Lets you reset your remote to its original default settings.

## Installing/Replacing Batteries

Install two (2) "AA" batteries as indicated by the diagram in the battery compartment.

When the illuminated buttons become dim or do not illuminate during use, install two (2) new "AA" size batteries.

Your remote control has Memory Guard, which eliminates reprogramming after battery changes.

## Programming Your Cable Converter

**The remotes are pre-programmed to operate Scientific Atlanta's Explorer converters.**

**To program your cable converter...**

1. Turn on your cable converter.
2. Press [CBL], and [SELECT] together – hold both buttons down until [CBL] illuminates, or the LED light blinks 3 times,
3. From the Cable Setup Code list, locate and enter the 3-digit code for your brand and model or hold [CH▲] down until converter turns off.
  - a. Scientific Atlanta only – If multiple codes are listed you may have to enter several codes until the converter turns off.
  - b. CheckMate only – Press and hold the [CH▲] down until converter turns off.
4. Press [CBL] to lock in the code. The [CBL] button/LED will blink 2 times and go out.

Write your converter brand & setup code \_\_\_\_\_.

## Programming Your TV

If you have a TV that is operated by remote control, it is recommended that you plug it directly into a wall outlet instead of the cable converter.

**To program your TV...**

1. Turn on your TV.
2. Press [TV], and [SELECT] together – hold both buttons down until [TV] illuminates, or the LED light blinks 3 times.

# Cox Digital Cable Remote Controls, *cont.*

### 3. CheckMates only

- a. From the TV Setup Code list located on page 13, enter a 3-digit code for your brand. If multiple codes are listed, you may have to enter several codes until your TV turns off.

***OR***

- b. Press and hold [CH▲] until your TV turns off. As soon as your TV turns off, release [CH▲].

### 3. Scientific Atlanta only

- a. From the TV Setup Code list located on page 13, enter a 3-digit code for your brand. If multiple codes are listed, you may have to enter several codes until your TV turns off.

***OR***

- b. Enter [991] then push [TV] until the TV powers off. Then push [SELECT] to lock in the code.

4. Press [MUTE]. If your TV turns back on, press [TV] to lock in the code. The [TV] button/LED will blink 2 times and go out. If your TV does not turn back on, repeat steps 3 and 4 until you can turn your TV off and on.

Write your TV brand & setup code \_\_\_\_\_.

**Note:** When using the Point and Press Programming method (step 3b) if you find a code that turns your TV off but not back on (step 4), you may have gone past the correct matching code. Try pressing [CH▼] one press at a time until you find a code that turns your TV back on.

## Programming Your Video (VCR/DVD) Device

### To program your VCR or DVD...

1. Turn on your VCR or DVD.
2. Press [VIDEO/VCR], and [SELECT] together – hold both buttons down until [Video] illuminates or the LED light blinks 3 times.
3. CheckMates only
  - a. From the VCR – DVD Setup Code list, locate and enter a 3-digit code for your brand. If multiple codes are listed, you may have to enter several codes until your VCR or DVD turns off.

***OR***

- b. Press and hold [CH▲] until your VCR or DVD turns off. As soon as your VCR or DVD turns off, release [CH▲].

### 3. Scientific Atlanta

- a. From the VCR – DVD Setup Code list, locate and enter a 3-digit code for your brand. If multiple codes are listed, you may have to enter several codes until your VCR or DVD turns off.

***OR***

- b. Enter [991] then push [VCR] until the VCR powers off. The push [SELECT] to lock in the code.

4. Press [MUTE]. If your VCR or DVD turns back on, press [VIDEO/VCR] to lock in the code. The [VIDEO/VCR] button/LED will blink 2 times and go out.

If your VCR or DVD does not turn back on, repeat steps 3 and 4 until you can turn your VCR or DVD off and on.

Write your VCR/DVD brand & setup code \_\_\_\_\_.

***NOTE:*** When using the Point and Press Programming method (step 3b.) if you find a code that turns your VCR/DVD off but not back on (step 4), you may have gone past the correct matching code. Try pressing [CH▼] one press at a time until you find a code that turns your VCR/DVD back on.

### **To program your TV/VCR combination unit....**

1. First, program your remote as a TV

Following the steps in this section, find a TV Setup Code that operates the TV functions of your TV/VCR (power, vol ▲/▼, mute, ch▲/▼, 0-9).

2. Then, program your remote as a VCR

Following the steps in Section 6 for code number programming – enter, lock and test each 3-digit VCR Setup Code until a code is found that operates the VCR functions of your TV/VCR (play, stop, fast-forward, rewind, pause, record).

***Note:*** You can not use the Point and Press Programming method to program the VCR functions of the TV/VCR.

### **Programming Your Audio Device** (CheckMate IV remote only)

To program your laser disc, compact disc, cassette tape player, receiver or amplifier...

1. Turn on your Audio device – cassette deck, CD, receiver, amplifier.
2. Press [AUDIO], and [SELECT] together – hold both buttons down until [AUDIO] illuminates.

# Cox Digital Cable Remote Controls, *cont.*

3. a. From the Audio Setup Code list, locate and enter a 3-digit code for your brand. If multiple codes are listed, you may have to enter several codes until your Audio device turns off.

*OR*

- b. Press and hold [CH▲] until your Audio device turns off. As soon as your Audio device turns off, release [CH▲].
4. Press [MUTE]. If your Audio device turns back on, press [AUDIO] to lock in the code. The [AUDIO] button will blink 2 times and go out.

If your Audio device does not turn back on, repeat steps 3 and 4 until you can turn your Audio device off and on.

Write your Audio brand & setup code \_\_\_\_\_.

## **To program your 2nd TV, 2nd VCR, or 2nd DVD.....**

1. Turn to your 2nd TV, 2nd VCR or 2nd DVD.
2. Press [AUDIO], and [SELECT] together – hold both buttons down until [AUDIO] illuminates.
3. Press [TV] to program a 2nd TV (or [VIDEO] for 2nd VCR). The [AUDIO] and [TV] buttons will blink.
4. a. From the TV Setup Code list, locate and enter a 3-digit code for your brand. If multiple codes are listed, you may have to enter several codes until your 2nd TV turns off.

*OR*

- b. Press and hold [CH▲] until your 2nd TV turns off. As soon as your 2nd TV turns off, release [CH▲].
5. Press [MUTE]. If your 2nd TV turns back on, press [AUDIO] to lock in the code. The [AUDIO] button will blink 2 times and go out. If your 2nd TV does not turn back on, repeat steps 3 and 4 until you can turn your 2nd TV off and on.

Write your 2nd TV brand & setup code \_\_\_\_\_.

**Note:** When using the Point and Press Programming method (step 4b), if you find a code that turns your Audio device off but not back on (step 4), you may have gone past the correct matching code. Try pressing [CH▼] one press at a time until you find a code that turns your Audio device back on.

TV BRAND	CODE	TV BRAND	CODE	TV BRAND	CODE
Admiral	058, 061, 062, 067, 107	Infinity	068	RCA	022, 027, 032, 033, 046, 053, 055, 061, 065, 072, 073, 082, 104, 149
Adventura	004, 060	Inkel	075	Realistic	012, 033, 044, 053, 057, 070, 168, 179, 192, 194
Aiko	106	Janeil	060	Rhapsody	199
Akai	044, 065	JBL	068	Runico	031, 044
Amark	007, 086	JCB	014	Sampo	031, 044, 053
Amstrad	006	JVC	048, 067, 077, 080	Samsung	007, 016, 020, 031, 033, 044, 053, 070, 074, 192
Alleron	193	Kawasho	041, 051	Samsux	053
Ambassador	191	KEC	194	Sanyo	002, 010, 028, 168, 173
Anam	088, 089, 093, 194	Kenwood	033, 044	Scimisu	033
Anam National	069	Kloss	060	Scotch	192
AOC	033, 044, 065, 199	KMC	007	Scott	031, 033, 044, 079, 192, 193, 194, 250
Audiovox	194	KTV	007, 030, 044, 053, 059, 065, 194, 199, 294	Sears	002, 007, 010, 016, 027, 028, 043, 061, 068, 069, 070, 168, 170, 173, 185, 192, 193
Belcor	033, 041	Kurazai	062	Sharp	007, 009, 023, 035, 053, 057, 107, 179
Bell & Howell	030, 062, 168	Lodgenet	062	Shogun	033
Bradford	194	Logik	030, 062	Signature	007, 030, 044, 058, 062, 067
Broksonic	011, 054	Luxman	027, 041, 051, 070	Simpson	201
Brockwood	033, 041	LXI	006, 035, 061, 067, 068, 168, 170, 192	Sony	014, 032, 038, 050, 066
Candle	027, 044, 052, 060, 070	Magnavox/	001, 005, 007, 068, 014, 026, 027, 031, 034, 014, 044, 052, 068, 081, 201	Soundesign	052, 192, 193, 194
Carnivale	044	Philips	001, 005, 007, 068, 014, 026, 027, 031, 034, 014, 044, 052, 068, 081, 201	Squareview	006, 185
Carver	068	Majestic	030, 062	SSS	033, 194
Celebrity	014	Marantz	003, 044, 065, 068, 076	Starlite	194
Centurion	044, 051	Matsushita	264	Supre-Macy	060, 071
Citizen	027, 044, 052, 053, 059, 060, 062, 070, 074, 106, 294	Megatron	086, 159, 192	Supreme	014
Clairtone	199	MEI	199	Sylvania	001, 005, 006, 026, 027, 031, 034, 044, 052, 068, 081
Concerto	041, 051, 070	Memorex	030, 062, 070, 164, 168, 192	Symphonic	004, 006, 185
Contec	020, 194, 199	MGA/	003, 027, 031, 033, 041, 044,	Tatung	019, 069
Coronado	007	Mitsubishi	051, 065, 076, 084, 107, 164, 192	Technics	065, 264
Craig	194	Midland	031, 053, 061, 065, 149	Technol Ace	193
Crown	007, 053, 194	Minutz	035	Techwood	027, 065, 070
Curtis Mathes	044, 053, 061, 062, 074, 168	Motorola	069, 107	Teknika	001, 007, 027, 030, 033, 052, 053, 062, 068, 070, 074, 079, 106, 164, 193, 194
CXC	194	MTC	033, 044, 070, 074, 199	Telerent	007, 062
Daewoo	027, 033, 039, 040, 041, 042, 051, 053, 090, 091, 092, 094, 106, 465	Multitech	194	TMK	027, 031, 070, 191, 192
Daytron	033, 041, 044, 051	NAD	170, 180, 192	Toshiba	016, 029, 043, 069, 074, 168, 170
Dumont	031, 041, 033	NEC	023, 027, 031, 033, 044, 070	Tosonic	199
Electroband	014, 199	Nikko	044, 106, 192	Totevision	053, 059
Electro Home	041, 051	Noshi	032	Universal	027, 070
Elektra	002	NTC	106	Vector Research	044
Emerson	007, 008, 011, 012, 017, 054, 033, 053, 065, 079, 168, 191, 192, 193, 194, 199, 250, 294, 296, 477	Onwa	194	Victor	067
Envision	041, 044, 051	Optimus	168, 180, 264	Vidikron	068
Fisher	010, 028, 168, 173	Oplonica	107, 179	Vidiech	027, 033, 192
Fujitsu	193	Orion	013, 017, 033, 045, 047, 078, 250	Viking	060
Funai	004, 185, 193, 194	Panasonic	018, 019, 021, 024, 053, 063, 065, 069, 264	Wards	007, 027, 030, 031, 033, 034, 035, 037, 044, 057, 058, 062, 065, 067, 068, 070, 179, 081, 192, 193
Futuretech	194	Penney	005, 010, 027, 032, 033, 035, 037, 041, 044, 051, 053, 061, 065, 069, 070, 074, 149, 170, 192	White/	
GE	005, 019, 027, 031, 035, 037, 041, 046, 051, 053, 055, 061, 065, 069, 070, 149, 192, 296, 465	Philco	001, 007, 027, 033, 034, 044, 052, 059, 065, 068, 081, 097	Westinghouse	058
Gibraltar	007, 025, 027, 031, 041, 044, 051, 059, 060, 065	Pilot	033, 041, 044, 053, 059, 097	XR-1000	062
Gibraltar	031, 033, 044	Pioneer	056, 180	Yamaha	027, 033, 044
GoldStar	007, 027, 031, 033, 041, 044, 053, 059, 060, 065, 070, 192	Portland	007, 027, 033, 053, 106	York	031, 044
Gundig	059	Prism	065	Zenith	030, 031
Grumpy	193, 194	Proscan	055, 061, 073, 082		
Hallmark	041, 051, 192	Proton	031, 192		
Harvard	194	Pulsar	031, 033, 041		
Hitachi	007, 027, 049, 051, 070, 159, 165, 083, 085	Quasar	019, 065, 069, 179, 264		
		Radio Shack	033, 041, 044, 053, 061, 070, 168, 179, 192, 194		

VCR BRAND	CODE	VCR BRAND	CODE	VCR BRAND	CODE
Admiral	014, 056, 062	JCL	008	Radio Shack	014, 051
Adventura	014, 025	Jensen	055	Radix	051
Alko	292	JVC	004, 005, 007, 022, 026, 038, 055, 060, 081	Randex	051
Alwa	014, 025	KEC	051, 292	RCA	001, 008, 016, 017, 027, 028, 037, 041, 046, 056, 074, 119, 120, 163, 216
Akai	011, 021, 051, 055, 075, 120	Kenwood	005, 007, 052, 055, 060, 081	Realistic	005, 014, 025, 030, 034, 049, 051, 060, 061, 062, 076, 118
American High	049	KLH	086	Ricoh	048
Asha	254	Kodak	049, 051	Runco	053
Audio Dynamics	007, 044	Lloyd	014, 025	Samsung	021, 028, 039, 059, 254
Audiovox	051	Lloyd's	222	Sanky	053, 062
Beaumarck	254	Logik	042, 086	Sansai	042
Bell & Howell	005, 024, 118	LXI	002, 025, 051	Sansui	055, 081
Broksonic	009, 048, 053, 064, 135, 198, 225	Magnavox	008, 025, 034, 036, 049, 053, 095, 163	Sanyo	005, 024, 030, 060, 061, 118, 254
Calix	051	Magnin	254	Scott	003, 006, 031, 042, 057, 059, 135, 198, 225, 226
Canon	008, 034, 049	Marantz	005, 008, 036, 044, 049, 060, 095	Sears	002, 005, 015, 030, 046, 049, 051, 056, 060, 061, 068, 118, 119
Capehart	034	Marta	002, 051	Sharp	014, 056, 062, 076
Carver	095	Matsushita	049, 176	Shintom	042, 086
CCE	086, 292	MEI	049	Shogun	254
Citizen	002, 006, 028, 051, 060, 292	Memorex	002, 005, 025, 030, 034, 014, 049, 051, 053, 060, 061, 062, 118, 254	Signature	014, 025, 027, 037, 062
Colortyme	044	MGA	057, 075	Singer	086
Colt	086	MGN Technology	254	Sony	032, 035, 046, 047, 048, 049, 050
Craig	028, 030, 051, 061, 086, 254	Minolta	056, 119	STS	056
Curtis Mathes	008, 013, 034, 044, 049, 055, 060, 074	Mitsubishi	023, 029, 031, 047, 057, 075, 081	Sylvania	008, 016, 014, 017, 025, 034, 036, 047, 049, 054, 057, 065, 073, 074, 095
Cybernex	254	Motorola	049, 062	Symphonic	014, 025
Daewoo	006, 010, 012, 034, 057, 058, 059, 292	MTC	014, 025, 028, 254	Tandy	005, 025
Daytron	034, 055, 058	Multitech	014, 025, 028, 042, 086	Tashiko	002
DBX	007, 044	NEC	005, 007, 044, 052, 055, 070, 071, 081, 118	Tatung	007, 055
Dynatech	014, 025	Nikko	051	Teac	007, 014, 025, 055
Electrohome	051	Nikon	048	Technics	008, 049, 176
Electrophonic	051	Noblex	254	Teknika	002, 014, 049, 051, 053
Emerex	046	Olympus	049	TMK	222, 254
Emerson	002, 003, 006, 008, 009, 014, 016, 022, 033, 040, 049, 051, 057, 064, 075, 135, 198, 222, 225, 226, 292, 493	Optimus	051, 062, 118, 176	Toshiba	006, 015, 046, 052, 057, 059, 226
Fisher	005, 015, 024, 030, 052, 061, 068, 118	Optonica	076	Totevision	002, 028, 051, 254
Fuji	047, 049	Orion	022, 049, 065, 066, 067, 068, 493	Unitech	028, 254
Funai	014, 025	Panasonic	008, 013, 034, 049, 176, 239	Vector	059
Garrard	014	Penney	005, 008, 017, 028, 034, 044, 046, 049, 051, 052, 056, 068, 254	Vector Research	031, 044, 052
GE	008, 027, 028, 034, 041, 049, 074, 216	Pentax	046, 056, 119	Video Concepts	044, 059, 075
GoldStar	002, 051, 052, 060	Philco	008, 034, 036, 049	Videosonic	254
Go Video	019, 043, 063	Phillips	008, 017, 034, 036, 049, 076, 095	Wards	002, 014, 025, 027, 028, 034, 037, 049, 056, 060, 061, 062, 074, 076, 086, 095, 163, 226, 254
Gradiente	014	Pilot	051	XR-1000	014, 042, 049, 086
Harley Davidson	014	Pioneer	045, 046, 081	Yamaha	005, 007, 044, 052
Harman/Kardon	044, 052	Portland	034, 058	Zenith	018, 035, 038, 047, 048, 053, 061
Harwood	086	Proflitronic	254		
Headquarter	060	ProScan	027, 041		
Hi-Q	061	Protoc	086		
Hitachi	025, 046, 055, 056, , 059, 119	Pulsar	053		
Instant Replay	008, 017, 034	Quarter	060		
		Quartz	005, 060		
		Quasar	013, 034, 049, 176		

RECEIVER BRAND CODE		RECEIVER BRAND CODE		RECEIVER BRAND CODE	
Denon	034, 068, 102	Philips	089	Sony	008, 020, 059, 091
Fisher	073	Pioneer	090, 058	Soundesign	048, 092, 093, 094
Goldstar(LG)	088	Radio Shack	012, 040	Zenith	048, 092, 093, 088, 094
Harman Kardon	043	Realistic	079	Teac	054, 064
JVC	053	Sanyo	044	Technics	095
Kenwood	045	Scott	055	Yamaha	030
Marantz	080	Sharp	082		
Onkyo	052	Sherwood	012, 040		

**NOTE:** If your digital converter is an Explorer 2100, you will need to add an additional “0” (zero) at the front of the code number when programming the VCR Commander. To program the remote, use the codes as listed here. All other digital converters models use the codes as listed for all applications.

## Programming [MOVIES], [SPORTS], [NEWS] (CheckMate remotes only)

Each of these buttons can be programmed to store a favorite cable channel.

For example, to program the "movies" button to cable channel 200, follow these steps:

1. Press [DEVICE], then [CBL] to select the remote's cable mode.
2. Press [CBL], and [MOVIES] together – hold both down until [CBL] illuminates.
3. Press [2], [0], [0]. (enter ch. # in 3-digit format).
4. Press [MOVIES] to store this channel. The [CBL] button will blink and go out.

Programming the [SPORTS] or [NEWS] buttons is the same general procedure as above.

## Operating Your Digital Converter

Your remote control is designed to operate all the features and functions of your digital converter.

**To operate your cable converter, press [DEVICE], then [CBL]. In your remote's cable mode, you can then press...**

[ALL]	All devices on/off (CheckMate IV remote only)
[CBL]	Cable converter on/off
[TV]	TV on/off
[VIDEO]	VCR/DVD on/off.
[AUDIO]	Audio on/off.
[CH▲]/[CH▼]	Increases/decreases cable channel.
[VOL▲]/[VOL▼]	Increases/decreases volume.
[MUTE]	Mute volume.
[EXIT]	Exits on-screen menus, guide and interactive screens.
[SETTINGS]	Displays program settings.
[GUIDE]	Displays interactive program guide.
[INFO]	Displays channel, time information and program descriptions.
[FAV]	View favorite channels.
[LAST]	Last channel viewed.
[A], [B], [C]	On-screen decision buttons.
[0] – [9]	Numeric entry buttons.

# Cox Digital Cable Remote Controls, *cont.*

- [PAGE▲/▼] Page up/down through menus, program guide.
- [◀], [▼], [▶], [▲] Navigate on-screen menus, program guide, PPV events and interactive services.
- [SELECT] Select menu, interactive screen item.
- [TV/VCR] Changes VCR video inputs.
- [VCR/VOD] "Toggles" the VCR buttons between cable VOD (video-on-demand) and VCR/DVD functions.

Press/switch [VCR/VOD]. If...

- a. [CBL] illuminates, the VCR buttons are operating your VOD functions.

*OR*

- b. [VIDEO] illuminates, the VCR buttons are operating your VCR or DVD functions.

While [CBL] or [VIDEO] is illuminated, press [VCR/VOD] to switch from VOD to VCR or VCR to VOD.

- [◀◀] VCR/DVD or VOD rewind.
- [▶] VCR/DVD or VOD play.
- [▶▶] VCR/DVD or VOD fast-forward.
- [||] VCR/DVD or VOD pause.
- [■] VCR/DVD or VOD stop.
- [●] VCR/VOD or VOD record.
- [MOVIES] Programmable favorite channel.
- [SPORTS] Programmable favorite channel.
- [NEWS] Programmable favorite channel.

## Operating Your TV

Your remote control can operate many functions of your TV.

For Scientific Atlanta remote, just push TV.

CheckMate remote – To operate your TV, press [DEVICE], then [TV]. In your remote's TV mode, you can then press...

- [ALL] All devices on/off. (CheckMate IV remote only)
- [CBL] Cable converter on/off.
- [TV] TV on/off.

[VIDEO]	VCR/DVD on/off.
[AUDIO]	Audio on/off. (CheckMate IV remote only)
[CH▲]/[CH▼]	Increases/decreases TV channel.
[0] – [9]	Numeric entry buttons.
[VOL▲]/[VOL▼]	Increases/decreases TV volume.
[MUTE]	Mute volume.
[TV/VCR]	Changes TV's video inputs.
[◀◀]	VCR/DVD rewind.
[▶]	VCR/DVD play.
[▶▶]	VCR/DVD fast-forward.
[  ]	VCR/DVD pause.
[■]	VCR/DVD stop
[●]	VCR/DVD record.

## Operating Your Video (VCR/DVD) Device

Scientific Atlanta remote just push VCR.

CheckMate remote – Your remote control can operate many functions of your VCR/DVD. To operate your VCR or DVD, press [DEVICE] then [VIDEO]. In your remote's Video mode, you can then press...

[ALL]	All devices on/off. (CheckMate IV remote only)
[CBL]	Cable converter on/off.
[TV]	TV on/off.
[VIDEO]	VCR/DVD on/off.
[AUDIO]	Audio on/off. (CheckMate IV remote only)
[CH▲]/[CH▼]	Increases/decreases VCR channel.
[0] – [9]	Enter VCR channels.
[VOL▲]/[VOL▼]	Increases/decreases TV volume.
[MUTE]	Mute TV volume.
[TV/VCR]	Changes VCR video inputs.
[◀◀]	VCR/DVD rewind.
[▶]	VCR/DVD play.

## Cox Digital Cable Remote Controls, *cont.*

[▶▶]	VCR/DVD fast-forward.
[  ]	VCR/DVD pause.
[■]	VCR/DVD stop
[●]	VCR/DVD record.

### Operating Your Audio Device (CheckMate IV only)

Your remote control can be setup to operate a cassette tape deck, CD, receiver, amplifier, 2nd TV, 2nd VCR as an Audio device.

**To operate your Audio device, press [DEVICE], then [AUDIO]. In your remote's Audio mode, you can press....**

[ALL]	All devices on/off. (CheckMate IV remote only)
[CBL]	Cable converter on/off.
[TV]	TV on/off.
[VIDEO]	VCR/DVD on/off.
[AUDIO]	Audio on/off. (CheckMate IV remote only)
[CH▲]/[CH▼]	Increases/decreases channel.
[0] – [9]	Enter channels.
[VOL▲]/[VOL▼]	Increases/decreases volume.
[MUTE]	Mute volume.
[TV/VCR]	Changes VCR/DVD video inputs.
[◀◀]	Rewind.
[▶]	Play.
[▶▶]	Fast-forward.
[  ]	Pause.
[■]	Stop
[●]	Record.

### Programming Volume Control

When you first program your remote, each device controls its own volume/mute (except VCR which defaults to the TV). The volume control options in each mode of the remote are:

<b>CBL</b>	Cable (default), TV or Audio.
<b>TV</b>	TV (default). Cable or Audio.
<b>VIDEO</b>	TV (default), Cable or Audio.
<b>AUDIO</b>	Audio device (default), Cable or TV.

## **To control volume/mute through your TV in the remote's cable mode...**

### CheckMates only

1. Press [CBL], and [SELECT] together – hold both buttons down until (CBL) illuminates.
2. Press [VOL▲], then [TV] for TV volume. The [CBL] button will blink and go out.

### Scientific Atlanta only

1. Press [CBL], and [SELECT] together – hold both buttons down until (CBL) illuminates.
2. Press [996] then [TV] to control the volume on the TV or [CBL] to control the volume on the digital converter.

To return volume control to your converter, repeat step 1, then press [VOL▲], then [CBL] in step 2.

## **To control volume/mute through your cable converter in the remote's Video mode...**

1. Press [VIDEO], and [SELECT] together – hold both buttons down until [VIDEO] illuminates.
2. Press [VOL▲], then [CBL] for Cable volume. The [VIDEO] button will blink and go out.

To return volume control to your TV, repeat step 1, then press [VOL▲], then [TV] in step 2.

## **Code Number Readback**

To identify a 3-digit setup code stored under the Point and Press method, follow these steps:

To identify the TV setup code...

1. Press [TV], and [SELECT] together – hold both buttons down until (TV) illuminates.

### CheckMates only

2. Press [INFO]. The [TV] button will "blink back" the code numbers, with a 1-second interval between each digit of the code.

### Scientific Atlanta only

2. Press [1]. The [TV] button will "blink back" the code numbers, with a 1-second interval between each digit of the code.

Example: For code "035", the remote will blink 10 times, then 3 times, then 5 times.

# Cox Digital Cable Remote Controls, *cont.*

To identify the 3-digit Video code, press [VIDEO], then [SELECT] in step 1, then press [INFO].

To identify the 3-digit Audio code, press [AUDIO], then [SELECT] in step 1, then press [INFO].

## Total Reset

To reset your remote control to its factory default settings....

1. Press [CBL], and [SELECT] together – hold both buttons down until [CBL] illuminates.
2. Press [SETTINGS], then [SETTINGS] again. The [CBL] button will blink 4 times and go out.

## Helpful Tips and Troubleshooting

1. An illuminated mode (power) button will remain on while the remote is in a programming mode. In the absence of an entry, the illuminated button will go out after 45 seconds.

When locking in your devices, the illuminated button will blink and go out.

2. When using the Point and Press programming method, you may find a code that turns your device off but not back on. If this happens...
  - a. the correct code has not been found. Continue to press [CH▲] until your devices turn on and off.

*OR*

- b. you may have gone past the correct matching code. Try pressing [CH▼] one press at a time until you find a code that turns your devices back on.
3. If the same button is pressed and held for 45 seconds, your remote control will turn itself off. This extends the battery life should the remote become lodged under or between heavy objects such as sofa cushions.
  4. If you have any questions concerning the operation of your digital converter, contact Cox Communications at (602) 277-1000.
  5. Whenever you are not using your Cox Digital Cable, the converter should be powered off to ensure that up to date information is loaded in the Interactive Program Guide (IPG).

## Browse by Time

The Interactive Program Guide (IPG) is a convenient way to find out what's on television and to view a list of upcoming programs. Lists of programs are available for any date in the next seven days.

***NOTE: Press GUIDE on the remote control to access the Interactive Program Guide (IPG) main screen as shown in the following illustration. The guide appears two hours ahead with the program on the first channel in the lineup highlighted. Press the "C" key to go to current time and channel.***

# Interactive Program Guide (IPG)

Use the *BROWSE BY TIME* feature to list the available programs in order by time of day.

1. Press [GUIDE] on the remote control. The IPG main screen appears in Browse by Time.
2. Press the [C] button to highlight current time and channel.

*OR*

Press the following buttons:

- [▲] and [▼] to move through the channels.
  - [◀] and [▶] to move through the time periods.
3. Press [SELECT] to watch the highlighted program if it is on now.



## Browse by Theme/Title/Date

A Theme is a category that describes the kind of programs available, such as Adventure, Comedy, or News.

1. Press [GUIDE] on the remote control. The IPG main screen appears in Browse by Time.

Press the [C] button to highlight current time and channel.

2. Press the [A] button to display the *BROWSE BY* menu, then press [▲] or [▼] arrow buttons to highlight *THEME/TITLE/ DATE*.
3. Press [SELECT]. The IPG appears in the Browse by Theme view with the theme for the program you are currently watching highlighted.

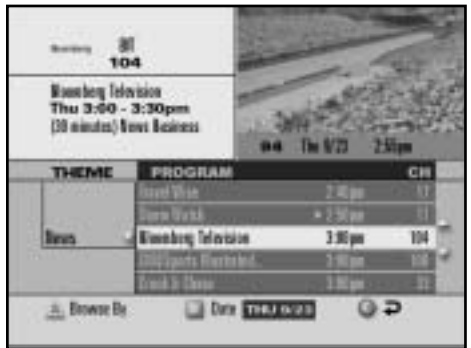

4. Press [▲] and [▼] to move through the programs for that theme, or press [◀] to move to the list of themes.

# Interactive Program Guide (IPG), *cont.*

- From the theme list, you can press[ ▲ ] and [▼]to move through the themes. Press [ ► ] or [SELECT] to move back to the list of programs for that theme. This example shows the theme *News* selected.

**Note:** Asterisks(\*) indicate that a program is showing now.

- Press the [C] button to highlight the program you are currently watching in the Theme view. Press [SELECT] to tune to the highlighted program in the current time period.

## Browse by Title

Use the *BROWSE BY TITLE* feature to list programs in alphabetical order by their title.

- Press [GUIDE] on the remote control. The IPG main screen appears in Browse by Time. Press the [C] button to highlight current time and channel.
- Press the [A] button to display the *BROWSE BY* menu. Press[ ▲ ] and [▼]to highlight *TITLE*.
- Press [SELECT]. The IPG appears in the Browse by Title view, with the title of the program you are currently watching highlighted.
- Press[ ▲ ] and [ ▼]to move through the programs by title, or press [◀] to move to the alphabetical list.

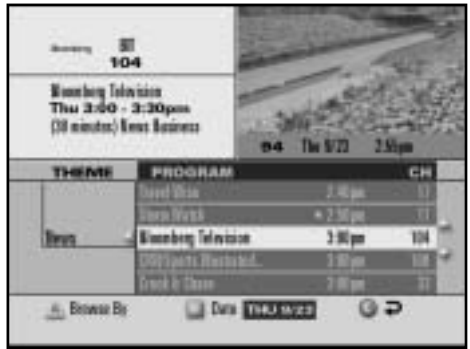

**Note:** Asterisks(\*) indicate that a program is showing now.

- From the alphabetical list, you can press[ ▲ ] or[ ▼]to move through the letters of the alphabet. Press [ ► ] or [SELECT] to move to the list of programs that begin with that letter.
- Press the [ C ] button to highlight the program you are currently watching in the Title view. Or, press [SELECT] to watch the highlighted program if it is in the current time period.

**Note:** Asterisks(\*) indicate that a program is showing now.

# Cox iN DEMAND Pay-Per-View

## What is Cox iN DEMAND?



Cox iN DEMAND is pay-per-view (PPV) events or movies that are not available on other channels. You can purchase Cox iN DEMAND events by pressing a button on your remote control or calling the phone number on the screen. Cox iN DEMAND events are charged to you on a pay-per-view basis, so you only pay for the programs you order. After you purchase a Cox iN DEMAND program, a dollar symbol in the Channel Banner indicates programs you have purchased.

## How to Order Cox iN DEMAND Pay-Per-View

You can order iN DEMAND pay-per-view movies from the IPG Guide screen simply by pressing [SELECT] while the movie is highlighted.

1. Press [GUIDE] on the remote control. The IPG main screen appears in Browse By Time. Press the [C] button to highlight current time and channel.
2. Press [▲][▼][▶][◀] to find the event you want to purchase. See your channel listing for Cox iN DEMAND (PPV) channels.
3. Press [SELECT].
4. If you can order the program at this time, the preview or purchase screen appears with the event information. Press the [B] button to buy the event, or follow the instructions on the screen.
5. If you have a Personal Identification Number (PIN) for Cox iN DEMAND purchases, the **Pin Entry** screen appears.
6. Enter your PIN to authorize the Cox iN DEMAND purchase.

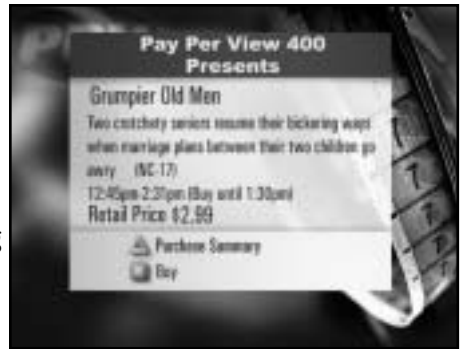

**Note:** Once the purchase has been authorized, a confirmation message appears for a few seconds if the program has already started. Otherwise, an attention screen counts down until the program begins.

## How to Change Your Pay-Per-View PIN

Your digital converter is installed with a pre-set PIN of (0000), you may wish to establish a PIN which only you know. You can change your pay-per-view PIN from the **General Settings** menu.

1. From the Interactive Program Guide, press [SETTINGS] on the remote control, or from a television program, press [SETTINGS] twice.

2. At the **General Settings** menu, press [▲] or [▼] to highlight *PPV: PIN*.
3. Press [SELECT].
4. Press [▲] or [▼] to highlight *CHANGE*.
5. Press [SELECT].
6. Enter your *CURRENT PIN*.
7. Enter your *NEW PIN*.
8. Re-enter your *NEW PIN* to confirm.
9. Press *EXIT* to return to watching television.

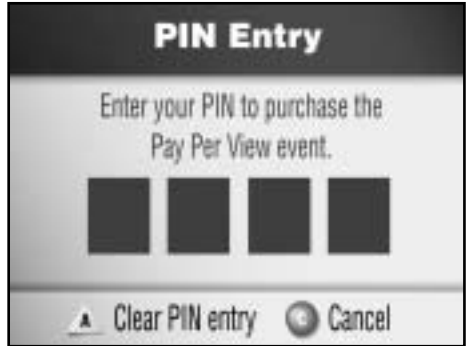

## How to See What You Have Ordered

The **Channel Banner** indicates Cox iN DEMAND programs you have purchased with a dollar symbol. You can also review your Cox iN DEMAND purchases from the **General Settings** menu. They are divided into three categories:

- PRE-PURCHASED*      Programs purchased by phone but not yet shown  
*PENDING*              Programs purchased using the remote control  
*PAST*                      Previously purchased programs and programs in progress

1. From the Interactive Program Guide, press [SETTINGS] on the remote control, or from a television program, press [SETTINGS] twice.
2. At the **General Settings** menu, press [▲] or [▼] to highlight *PPV: PURCHASES*.
3. Press [SELECT].
4. Enter your PPV PIN, if required.
5. Press [▲] or [▼] to highlight *PAST*, *PRE-PURCHASED*, or *PENDING*.
6. Press [SELECT]. The programs are listed.
7. Press [EXIT] to return to watching television.

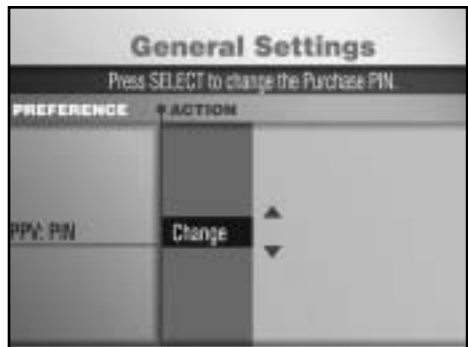

# Cox iN DEMAND Pay-Per-View

## How to Cancel A Cox iN DEMAND Order

You can cancel an order from the **General Settings** menu. You can cancel any Pre-purchased or Pending program. You cannot cancel Past programs.

1. From the Interactive Program Guide, press **[SETTINGS]** on the remote control, or from a television program, press **[SETTINGS]** twice.
2. At the **General Settings** screen, press **[▲]** or **[▼]** to highlight **PPV: PURCHASES**, then press **[SELECT]**.
3. Press **[▲]** or **[▼]** to highlight **PENDING**, then press **[SELECT]**. The programs you have ordered are listed.
4. Press **[▲]** or **[▼]** to highlight the program you want to cancel, then press **[SELECT]**. Press the **[A]** button to confirm the cancellation. The order is cancelled.
5. Enter your PPV PIN, if required.
6. Press **[EXIT]** to return to watching television.

**Note:** You can't cancel adult programming after it has been ordered.

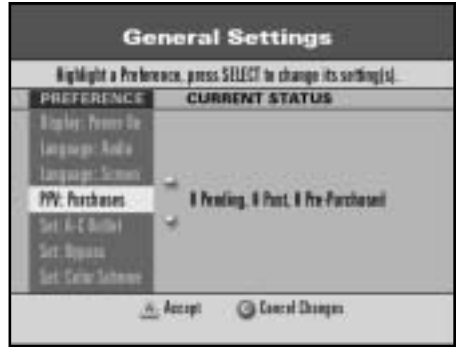

# Parental Control Features

## What Is Parental Control?



The Parental Control feature enables you to block programs by channel, program rating, or time of day. You select the channels, ratings, or times to block from the **General Settings** screen. The **Channel Banner** shows a padlock symbol for blocked channels and blocked programs. It also shows a padlock if any part of the program is blocked by time or rating.

## How to Change Your Parental Blocking PIN

Your digital converter is installed with a pre-set PIN of (0000), you may wish to establish a PIN which only you know. You can change your Parental Blocking PIN from the **General Settings** menu.

1. From the Interactive Program Guide, press **[SETTINGS]** on the remote control, or from a television program, press **[SETTINGS]** twice.
2. At the **General Settings** menu, press **[▲]** or **[▼]** to highlight **BLOCK: PIN**, then press **[SELECT]**.
3. Press **[▲]** or **[▼]** to highlight **CHANGE**, then press **[SELECT]**.
4. Enter your **CURRENT PIN**.
5. Enter your **NEW PIN**.
6. Re-enter your **NEW PIN** to confirm.
7. Press **[EXIT]** to return to watching television.

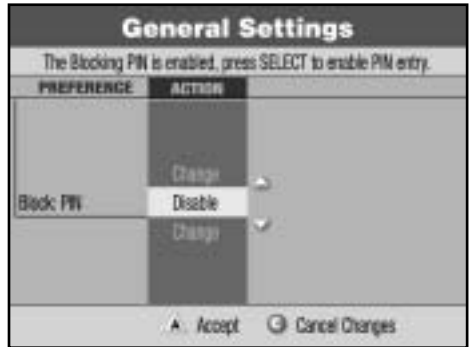

# Parental Control Features, *cont.*

## How to Block Channels

You can block channels by channel number, rating or time of day by using the procedure listed below.

1. From the Interactive Program Guide, press [SETTINGS] on the remote control, or from a television program, press [SETTINGS] twice.
2. At the **General Settings** menu, press [▲] or [▼] to highlight **BLOCK: CHANNELS**, then press [SELECT].
3. Enter your Parental Control PIN, if required.
4. Use [▲] or [▼] to highlight each channel you want to block.
5. Press [SELECT]. The **CHANNEL ID** is listed in the column on the right and a lock appears in the Channels list by each channel you selected.

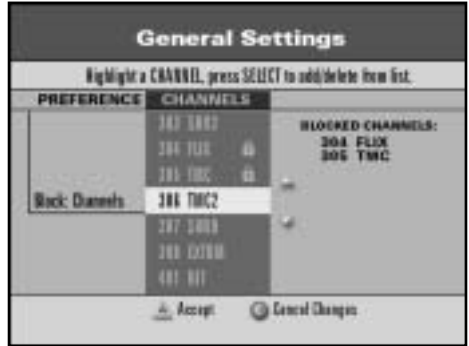

- Note:** You can press [SELECT] again to unblock the channel.
6. Continue highlighting and selecting channels you want to block.
  7. When all channels that you want to block have a padlock shown, press the [A] button to accept.
- Note:** Blocks do not take effect until you turn Parental Control on.
8. To turn the Parental Control feature on and off, follow the instructions for **How to Turn Parental Control On or Off**.
  9. Press [EXIT] to return to watching television.

## How to Watch A Blocked Program



Parental Control can be disabled by unlocking an individual program, channel number or time frame by the following steps:

1. Tune to the blocked channel.
2. Enter your Parental Control PIN.
3. Follow the on screen instructions.

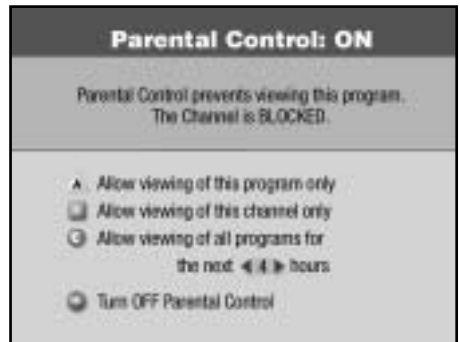

## How to Turn Parental Control Off



When Parental Control is on, the blocks set up earlier are enabled—blocked channels or programs are locked out.

A padlock symbol on the **Channel Banner** shows that a channel or program is blocked. When parental blocking is off, an open or unlocked padlock symbol on the **Channel Banner** identifies each parental blocking channel or program.

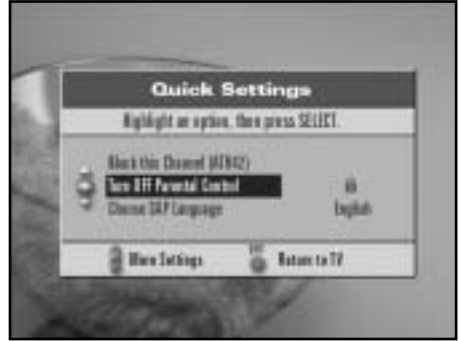

1. While watching any television program full-screen, press [SETTINGS].
2. At the **Quick Settings** menu, press [▲] or [▼] to highlight *TURN OFF/ON PARENTAL CONTROL*. (This line changes to show whether Parental Control is off or on.)
3. Press [SELECT] to change setting to *ON* or *OFF*. The PIN Entry screen appears.
4. Enter your Parental Control PIN.

**Note:** Each time you power off the digital converter, the Parental Control is automatically turned ON, if it is set up.

# Using The VCR Commander

## What Is The VCR Commander

**REC** The VCR Commander works with your digital converter to control VCR programming. With the VCR Commander, you can easily record programs whether your television is on or off. You simply select programs to record from the IPG, or use the program timer feature. The **REC** appears on the IPG indicating that a VCR timer has been set.

Before you can use the VCR Commander, you must connect the equipment and tell the VCR Commander which brand of VCR you have.

## Installing The VCR Commander

### Attaching the Serial Connector

**WARNING:** To avoid electric shock, disconnect the digital converter from the AC outlet before attaching the serial connector.

**To attach the serial connector to the digital converter:**

1. Disconnect the digital converter from the power outlet.
2. Locate the port labeled DATA on the back of the digital converter.
3. Align the serial connector with the digital converter's data port.
4. Tilt the VCR Commander approximately 30 degrees toward the top cover of the digital converter.
5. Slide the VCR Commander clip under the top cover.

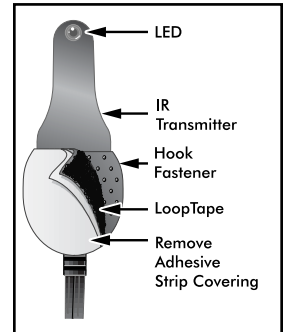

**Note:** On Explorer 2100 the VCR commander plugs into the headphone outlet.

### Attaching the Infrared (IR) Transmitter

1. Refer to your VCR's User's Guide to locate the IR sensor window. (The IR sensor responds to the remote control.)
2. Remove the covering on the adhesive strip which is attached to the tape fastener on the IR transmitter.
3. Attach the IR transmitter to the VCR. After attaching the IR transmitter to the VCR, the hook and loop fastener allows you to easily remove the IR transmitter for cleaning or to reposition the VCR.
4. Mount the IR transmitter within at least three inches of your VCR's IR receiver by pressing the IR transmitter against your VCR to secure it.

## Typical VCR

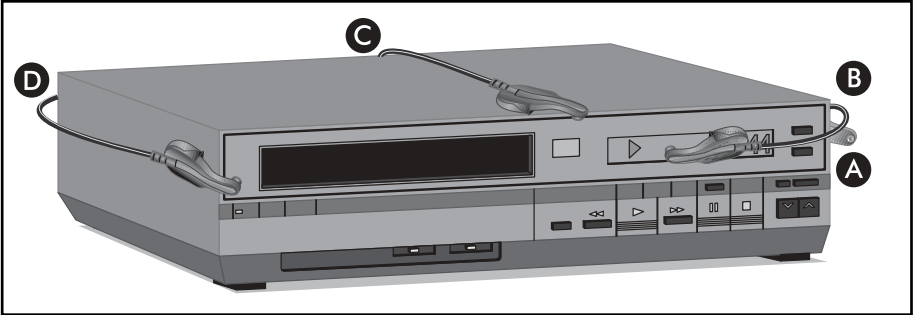

5. A, B, C and D above show typical places where your IR transmitter can be attached (within at least three inches of your VCR's IR receiver).

## Setting Up the VCR Commander

After you connect the VCR Commander, you must program your brand of VCR into the VCR Commander's memory.

Before you begin:

- Be sure the VCR is off.
- Be sure the TV is on and tuned to your cable channel 4.

Use your Cox Digital remote control to set up the VCR Commander.

1. Power on your digital converter.
2. Press **[SETTINGS]** twice to display the **General Settings** screen.
3. Press **[▲]** and **[▼]** to scroll to the **SET: VCR COMMANDER** option.
4. Press **[SELECT]**, then press **[▲]** and **[▼]** to scroll to **SETUP**.
5. Press **[SELECT]** to display the **VCR Commander Instructions** screen.
6. Turn to the **VCR Setup Codes** section to find the code(s) for your brand of VCR.
7. Enter the code for your brand of VCR, then press **[SELECT]**. If there is more than one code for your brand of VCR, try the first code listed.
8. Is your VCR on?

## Using The VCR Commander , cont.

9. If none of the VCR codes power on your VCR, use the Code **0-0-0** to scan the entire library. Follow these steps:
  - a. Enter **0-0-0**.
  - b. Press **[SELECT]**.
  - c. Wait three seconds, then press **[SELECT]** again. (Repeat until your VCR powers on.)
10. Follow the on-screen instructions to make a test recording.

**Note:** Because there is a 3-second test period for each code in the VCR library, be aware that it may take quite a bit of time if you use the Code **0-0-0**. If entering Code **0-0-0** and the VCR Commander does *not* power on your VCR, call Cox Technical Support for help at the number provided at the front of this guide.

### How To Record Current Programming

Recording has never been so easy! Your VCR Commander works with your digital converter to control VCR recording with one touch.

**To record what you're currently watching:**

1. Make sure a blank tape is in your VCR and power is OFF.
2. Press **[SETTINGS]** once to display the **Quick Settings** screen.
3. Use **[▲]** and **[▼]** to highlight **START RECORDING NOW**.
4. Press **[SELECT]** to access the **Recording Alert** screen.
5. Press **[SELECT]** to start recording.
6. To stop recording, press **[EXIT]**.

### How To Record Future Programming

You can record a program showing at a future date and time with Future Record. Select a program to be recorded daily or weekly, up to 7 days in advance.

**To record a future program:**

1. Make sure the DIGITAL CABLE CONVERTER is powered ON.
2. Place a blank tape into the VCR and turn the power OFF.
3. Press **[GUIDE]** and the IPG appears.
4. Use **[▲]** and **[▼]** to highlight the future program you want to record.
5. Press **[SELECT]** and the **Future Program Options** screen appears.
6. Press **[▲]** and **[▼]** highlight **SET A VCR TIMER** for your program.

## Using The VCR Commander , cont.

7. Press [SELECT] to set the Timer. The main IPG screen shows your program highlighted. The **REC** appears on the IPG indicating that a VCR timer is set.
8. Press [EXIT] to return to TV viewing.

### **To record a regular scheduled event:**

1. Follow instructions to program a single event on page \_\_\_\_
2. Push [SETTINGS] twice.
3. Push [▲] or [▼] to highlight the event.
4. Push [▶] to highlight channel.
5. Push [▶] to highlight day.
6. Push [▲] or [▼] to locate frequency of event (every Wed. or weekday, etc.)
7. Make any other necessary changes.
8. Push [A] to accept.